

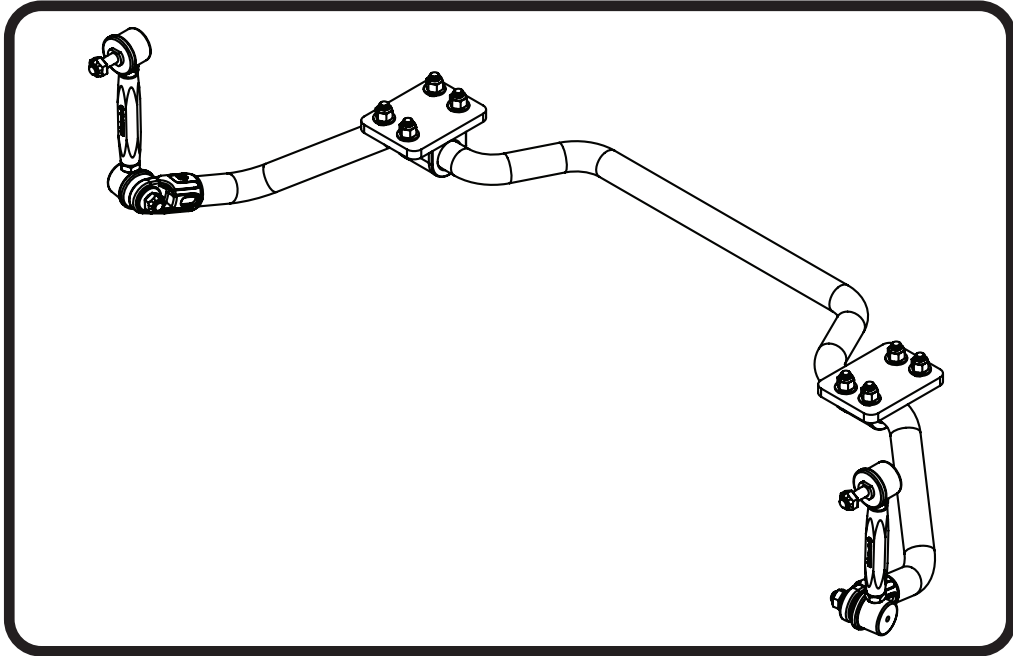

**Part # 12099100 - 1964-1966 Mustang Front MuscleBar**



**Recommended Tools**



# 1964-1966 Mustang Front MuscleBar Installation Instructions

Table of contents
Page 2..... Included Components and Hardware List
Page 3-5..... Sway Bar Installation

THIS SWAYBAR KIT IS DESIGNED TO BE USED WITH RIDETECH STRONGARMS ONLY. IT WILL NOT FIT THE OEM CONTROL ARMS.



### Major Components .....In the box

Part #	Description	QTY
90003248	Front Sway Bar	1
70012402	Delrin Sway Bar Bushing Liner	2
90002572	Bushing Strap	2
90002539	Sway Bar Bushing	2
90003213	Offset Mounting Plate	2
90002571	90 Degree End Link	4
90001253	Sway Bar End Link T-Bushing	2
90001258	End Link to Sway Bar Adapter Bushing	4

### Hardware List .....In the box (Kit# 99010162)

Part #	Description	Usage	QTY
99371005	3/8" -16 x 1 1/4" Hex Bolt	Bushing Strap to Frame Mount	8
99373002	3/8" Flat Washer	Bushing Strap to Frame Mount	16
99372001	3/8" -16 Nylok Nut	Bushing Strap to Frame Mount	8
99623001	5/8" SAE Flat Washer	NOT USED FOR THIS INSTALL	2

### Getting Started.....

**THIS SWAYBAR KIT IS DESIGNED TO BE USED WITH RIDETECH STRONGARMS ONLY. IT WILL NOT FIT THE OEM CONTROL ARMS.**

**Install all Front suspension components before installing the MuscleBar.**

Remove the OEM sway bar to prepare for the MuscleBar installation.

This sway bar kit utilizes a delrin liner in the sway bar Bushing. The delrin liner allows the sway bar to move freely and quietly in the bushing. The delrin is self-lubricating, no lubrication is required.



**1.** The delrin liner is split on one side to ease installation. Install a liner on each side of the swaybar in the approximate location they will need to be when installing the sway bar on the car.

**Note:** The delrin is self-lubricating, no lubricant is needed.



### Sway Bar Installation



2. Open up the poly sway bar bushings and install them over the delrin sleeves.

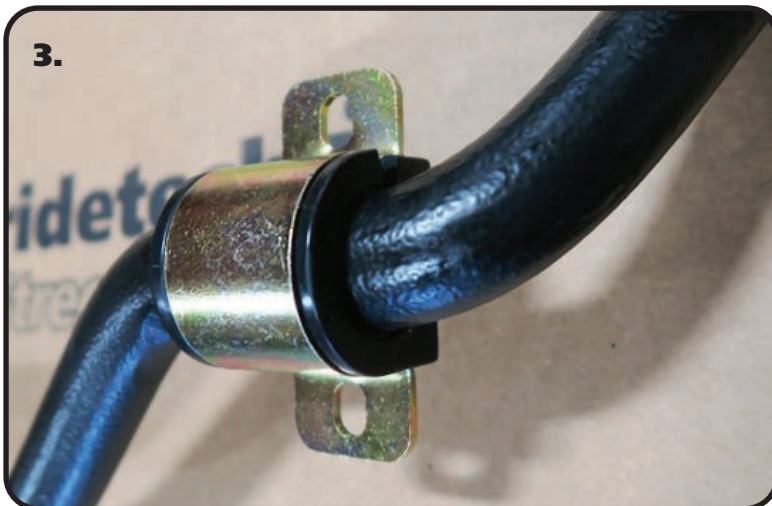

3. Install bushing straps over the poly sway bar bushings.



4. The offset mounting plate will get bolted to the OEM sway bar mount. It is bolted to the OEM holes using the SLOTTED holes in the offset plate with the (2) round holes offset toward the engine. Install a 3/8" flat washer on (2) 3/8"-16 x 1 1/4" hex bolts. A bolt/washer will go in each of the (2) mounting holes. Insert a bolt/washer through each slotted hole and OEM mounting hole. With the bolt/washers installed, install a 3/8" flat washer on the threads followed by a 3/8"-16 nylok nut. Torque the hardware to 30 ftlbs.



### Sway Bar Installation

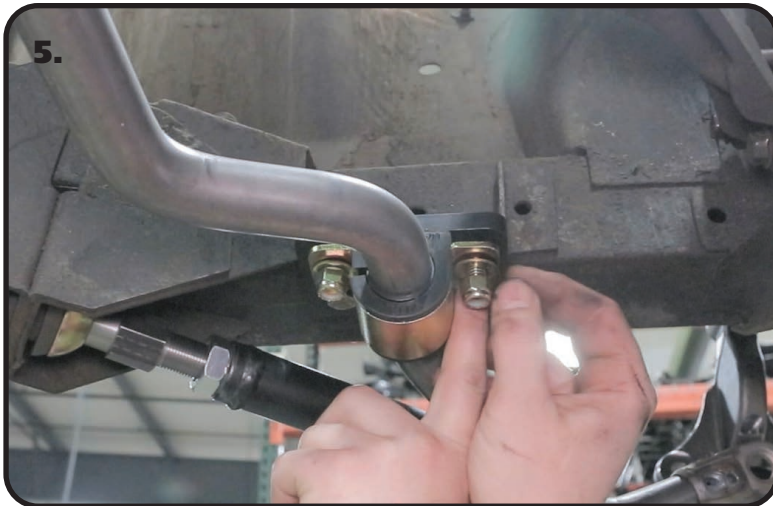

5. Slide the sway bar into position on the car. The sway bar arms will be bending upward with the center dropping toward the ground. Install a 3/8" flat washer on (4) 3/8"-16 x 1 1/4" hex bolts. A bolt/washer will go in each of the 4 mounting holes. With the bolt/washers installed, install a 3/8" flat washer on the threads followed by a 3/8"-16 nylok nut. Do **NOT** completely tighten the hardware. It will be left partially loose until the end links are installed.

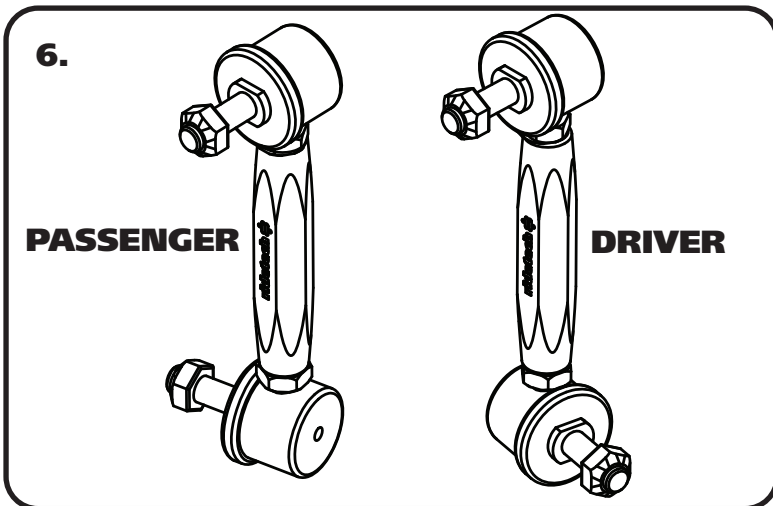

6. The driver and passenger sway bar linkages are clocked opposite of each other. With the top stud pointing toward you, the stud on the lower should be pointing to the right for the driver side, to the left for the passenger side. Using **Diagram 6** as a reference, set the linkage to 6" center to center. Snug the jam nuts against the center adapter.

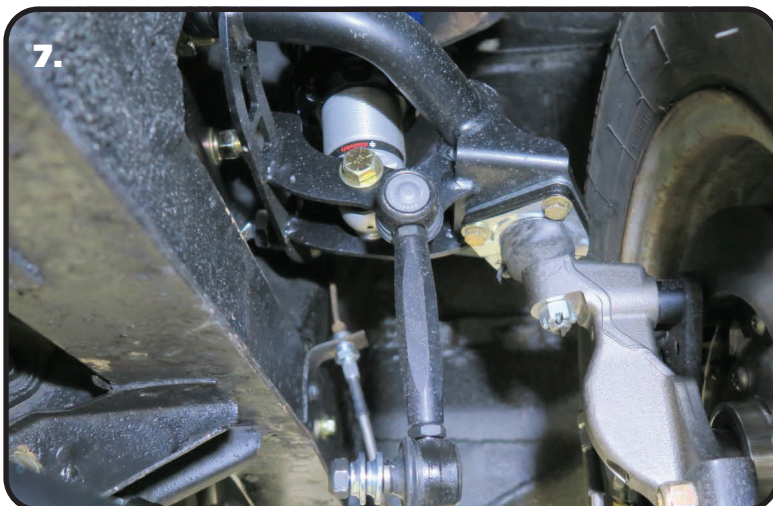

7. Remove the nut from the top end link. Insert the stud of the end link in the tab of the upper control arm with the stud pointing to the rear of the car. The lower stud should be pointing toward the engine. Install the nut on the stud of the end link and torque to 37 ftlbs. Repeat on the second side.



### Sway Bar Installation



**8.** Remove the nut from the bottom end link. Install a t-bushing on the lower 90 degree end link. The t-bushings are installed with the large diameter against the shoulder of the end link.

Drivers side shown in picture.



**9.** Insert the 90 degree end link/t-bushing into the swaybar end with the threads pointing toward the engine.

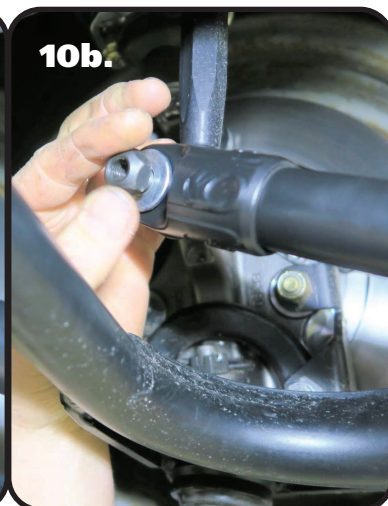
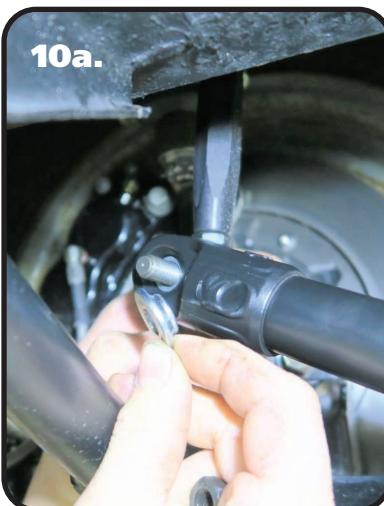

**10a & 10b.** Install a 2nd t-bushing with the small diameter into the swaybar. Install the nut and torque to 37 ftlbs. Do this for both sides.

**11.** The bushing strap hardware can now be tightened. Torque to 30 ftlbs.

**12.** Check sway bar and end link clearance through full suspension travel.

**13.** Ensure that the end links do not bind through full suspension travel.